

DESIGN QUARTER AT DUBAI DESIGN DISTRICT



FLOOR PLANS

TOWER A



TOWER A
1 Bedroom Type 02

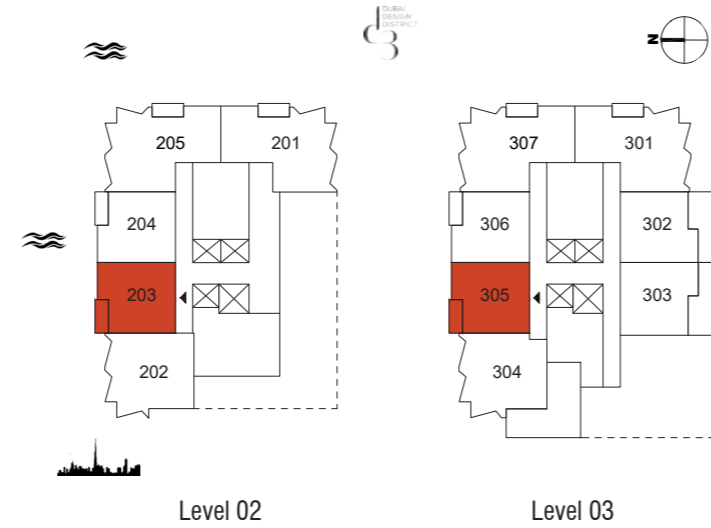

Unit No.	Unit Area		Balcony Area		Total Area	
	Sqm	Sqft	Sqm	Sqft	Sqm	Sqft
203	69.78	751.11	5.80	62.43	75.58	813.54
305	69.79	751.21	5.80	62.43	75.59	813.64

TOWER A
1 Bedroom Type 02 M

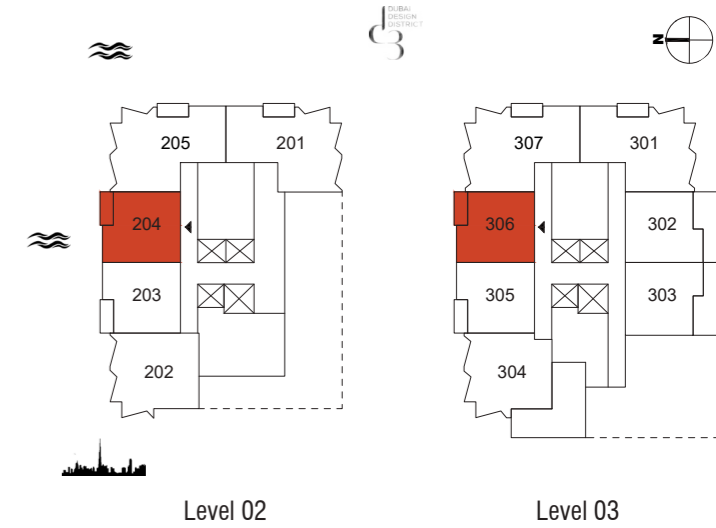

Unit No.	Unit Area		Balcony Area		Total Area	
	Sqm	Sqft	Sqm	Sqft	Sqm	Sqft
204	69.78	751.11	5.80	62.43	75.58	813.54
306	69.79	751.21	5.80	62.43	75.59	813.64

TOWER A
1 Bedroom Type 02



Levels 04 to 15



Tower A

Unit No.	Unit Area		Balcony Area		Total Area	
	Sqm	Sqft	Sqm	Sqft	Sqm	Sqft
402 to 1502	70.63	760.25	5.80	62.43	76.43	822.68
406 to 1506	70.65	760.47	5.80	62.43	76.45	822.90

TOWER A
1 Bedroom Type 02 M



Levels 04 to 15



Tower A

Unit No.	Unit Area		Balcony Area		Total Area	
	Sqm	Sqft	Sqm	Sqft	Sqm	Sqft
403 to 1503	70.63	760.25	5.80	62.43	76.43	822.68
407 to 1507	70.65	760.47	5.80	62.43	76.45	822.90

TOWER A
1 Bedroom Type 02 B

TOWER A
1 Bedroom Type 02 B M



Unit No.	Unit Area		Balcony Area		Total Area	
	Sqm	Sqft	Sqm	Sqft	Sqm	Sqft
302	69.79	751.21	24.14	259.84	93.93	1011.05



Unit No.	Unit Area		Balcony Area		Total Area	
	Sqm	Sqft	Sqm	Sqft	Sqm	Sqft
303	69.79	751.21	24.00	258.33	93.79	1009.54

TOWER A
1 Bedroom Type 03

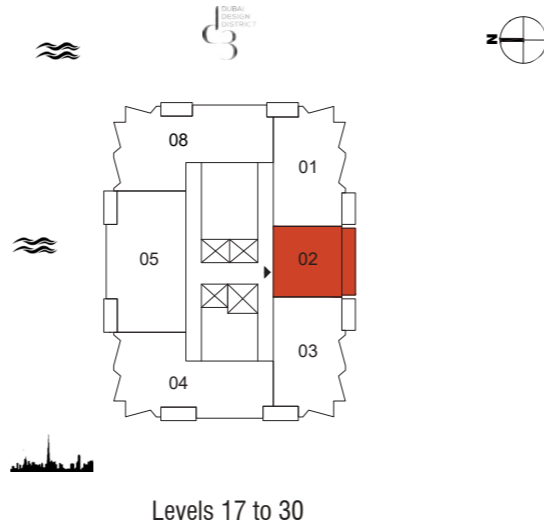

Unit No.	Unit Area		Balcony Area		Total Area	
	Sqm	Sqft	Sqm	Sqft	Sqm	Sqft
1702 to 3002	66.08	711.28	12.27	132.07	78.35	843.35

TOWER A
1 Bedroom Type 06



Unit No.	Unit Area		Balcony Area		Total Area	
	Sqm	Sqft	Sqm	Sqft	Sqm	Sqft
202	87.42	940.98	0.00	0.00	87.42	940.98

TOWER A
1 Bedroom Type 06 B



Tower A

Unit No.	Unit Area		Balcony Area		Total Area	
	Sqm	Sqft	Sqm	Sqft	Sqm	Sqft
304	87.34	940.12	51.86	558.22	139.20	1498.34

TOWER A
2 Bedroom Type 02

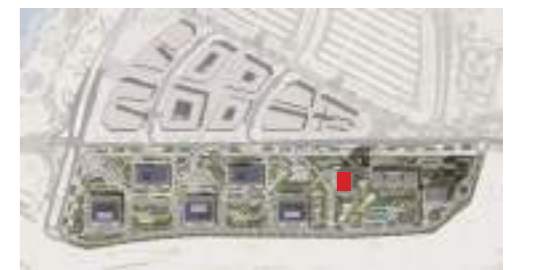
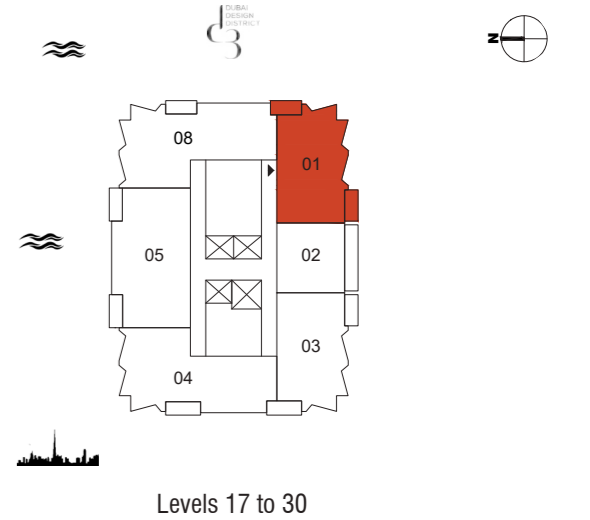

Tower A

Unit No.	Unit Area		Balcony Area		Total Area	
	Sqm	Sqft	Sqm	Sqft	Sqm	Sqft
1701 to 3001	105.80	1138.82	11.68	125.72	117.48	1264.54

TOWER A
2 Bedroom Type 02 M



Levels 17 to 30



Tower A

Unit No.	Unit Area		Balcony Area		Total Area	
	Sqm	Sqft	Sqm	Sqft	Sqm	Sqft
1703 to 3003	105.17	1132.04	11.68	125.72	116.85	1257.76

TOWER A
2 Bedroom Type 03

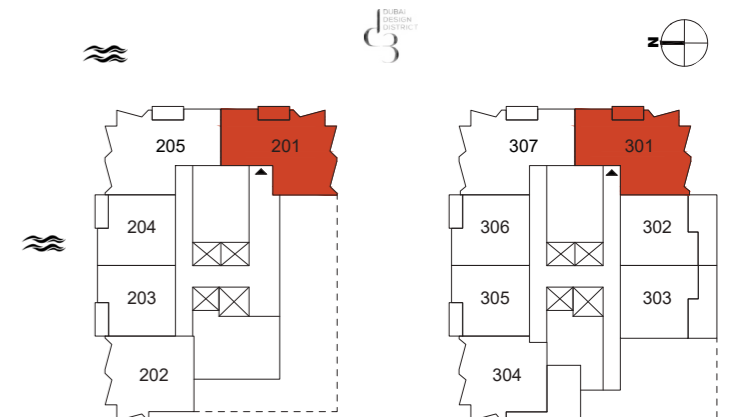

Level 02

Level 03



Tower A

Unit No.	Unit Area		Balcony Area		Total Area	
	Sqm	Sqft	Sqm	Sqft	Sqm	Sqft
201	103.44	1113.42	5.81	62.54	109.25	1175.96
301	103.48	1113.85	5.81	62.54	109.29	1176.39



Level 02

Level 03



Tower A

Unit No.	Unit Area		Balcony Area		Total Area	
	Sqm	Sqft	Sqm	Sqft	Sqm	Sqft
205	103.39	1112.88	5.81	62.54	109.20	1175.42
307	103.48	1113.85	5.81	62.54	109.29	1176.39

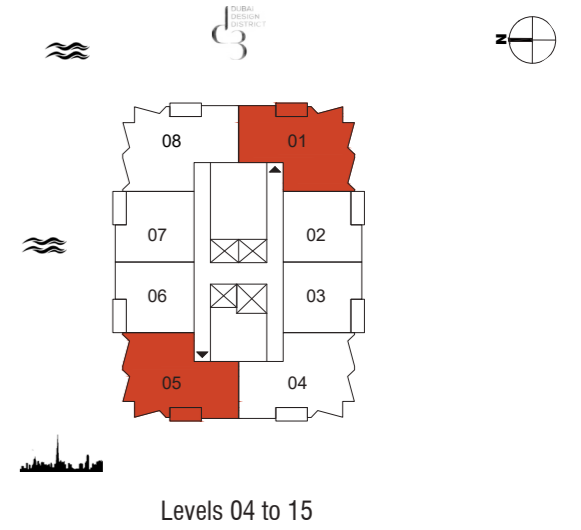

Levels 04 to 15



Tower A

Unit No.	Unit Area		Balcony Area		Total Area	
	Sqm	Sqft	Sqm	Sqft	Sqm	Sqft
401 to 1501	104.23	1121.92	5.81	62.54	110.04	1184.46
405 to 1505	104.28	1122.46	5.81	62.54	110.09	1185.00

TOWER A
2 Bedroom Type 03 M

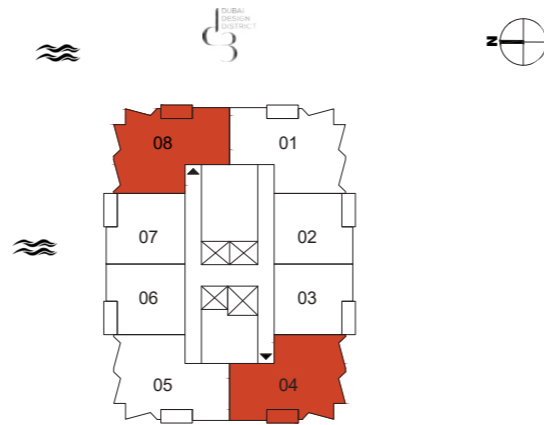

Levels 04 to 15



Tower A

Unit No.	Unit Area		Balcony Area		Total Area	
	Sqm	Sqft	Sqm	Sqft	Sqm	Sqft
404 to 1504	104.26	1122.25	5.81	62.54	110.07	1184.79
408 to 1508	104.25	1122.14	5.81	62.54	110.06	1184.68

TOWER A
3 Bedroom Type 01

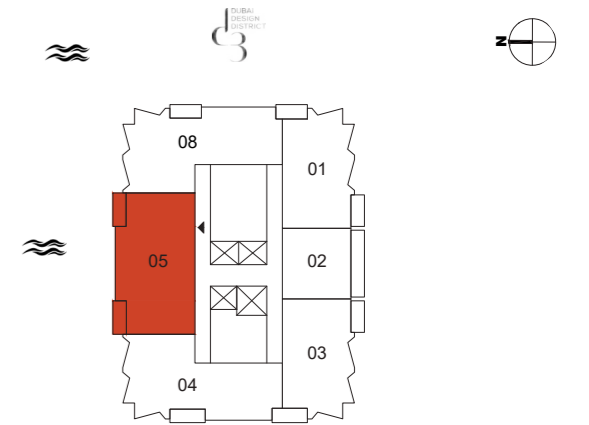

Levels 17 to 30



Tower A

Unit No.	Unit Area		Balcony Area		Total Area	
	Sqm	Sqft	Sqm	Sqft	Sqm	Sqft
1705 to 3005	144.83	1558.94	11.59	124.75	156.42	1683.69

TOWER A
3 Bedroom Type 02



Unit No.	Unit Area		Balcony Area		Total Area	
	Sqm	Sqft	Sqm	Sqft	Sqm	Sqft
1704 to 3004	137.89	1484.24	5.81	62.54	143.70	1546.78

TOWER A
3 Bedroom Type 02 M



Unit No.	Unit Area		Balcony Area		Total Area	
	Sqm	Sqft	Sqm	Sqft	Sqm	Sqft
1706 to 3006	137.89	1484.24	5.81	62.54	143.70	1546.78

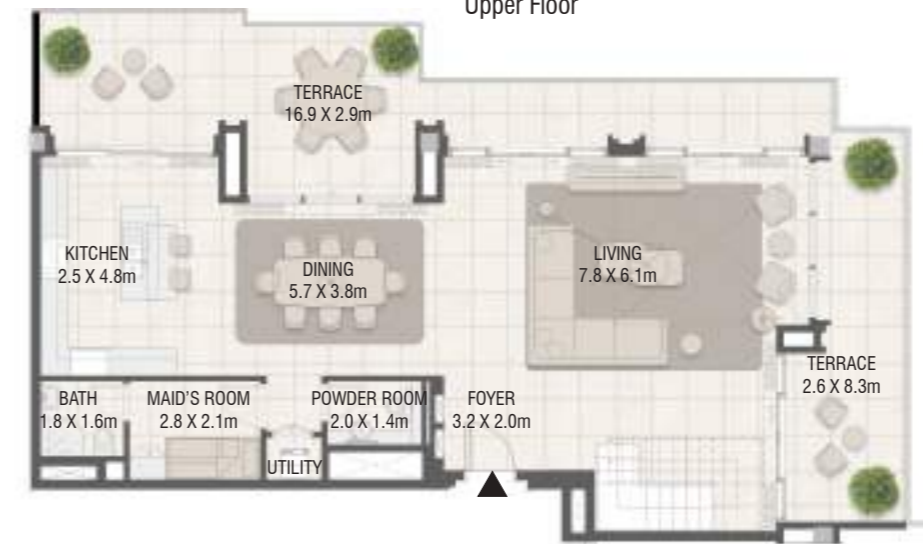
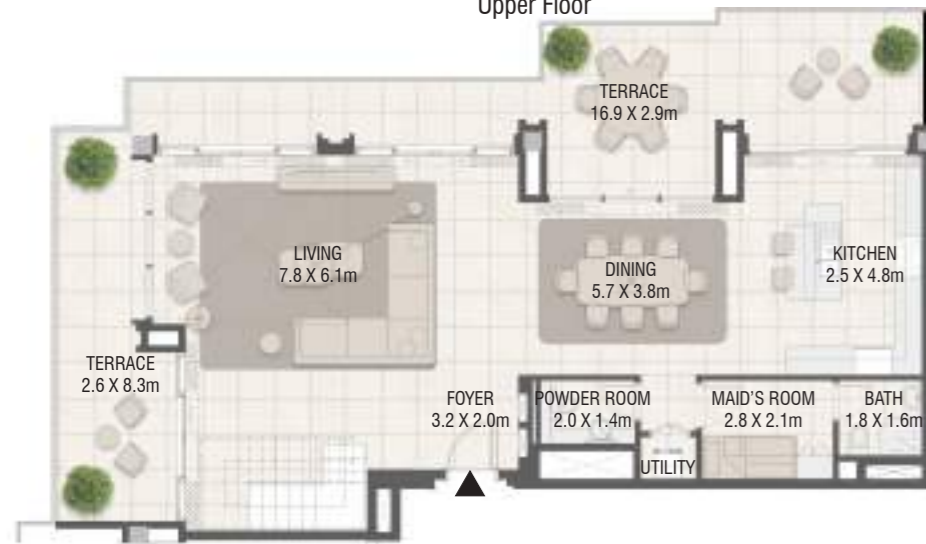
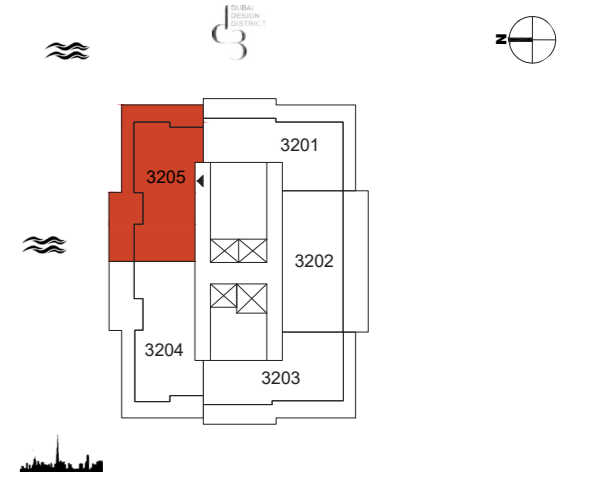
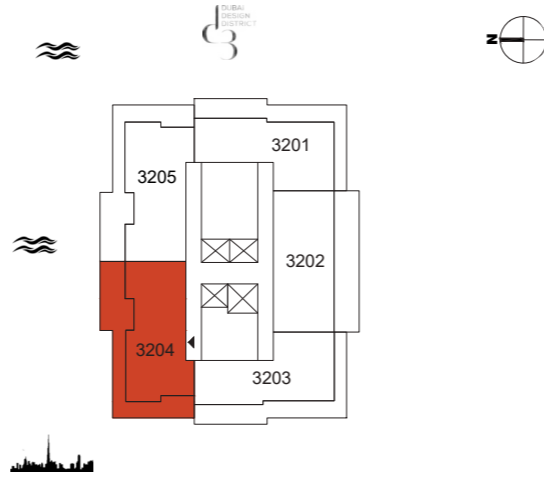

Unit No.	Unit Area		Balcony Area		Total Area	
	Sqm	Sqft	Sqm	Sqft	Sqm	Sqft
3204	236.88	2549.76	71.99	774.89	308.87	3324.65

Unit No.	Unit Area		Balcony Area		Total Area	
	Sqm	Sqft	Sqm	Sqft	Sqm	Sqft
3205	236.87	2549.65	71.99	774.89	308.86	3324.54

DESIGN QUARTER AT 3

DUBAI DESIGN DISTRICT



Upper Floor



Lower Floor

Unit No.	Unit Area		Balcony Area		Total Area	
	Sqm	Sqft	Sqm	Sqft	Sqm	Sqft
3201	196.28	2112.74	59.45	639.91	255.73	2752.65

TOWER A

Duplex - 3 Bedroom Type 06 M

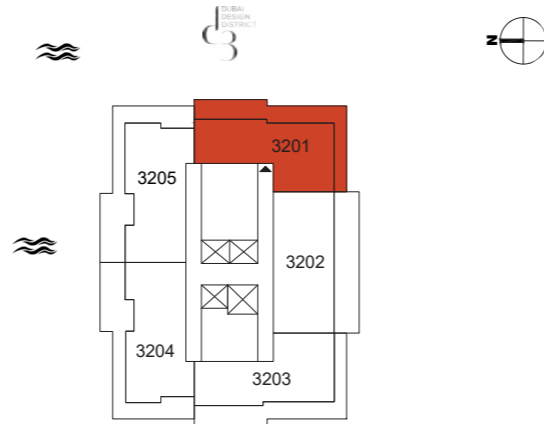

Level 32



Tower A

DESIGN QUARTER AT 3

DUBAI DESIGN DISTRICT



Upper Floor



Lower Floor

Unit No.	Unit Area		Balcony Area		Total Area	
	Sqm	Sqft	Sqm	Sqft	Sqm	Sqft
3203	196.31	2113.06	59.45	639.91	255.76	2752.97

TOWER A

Duplex - 3 Bedroom Type 06

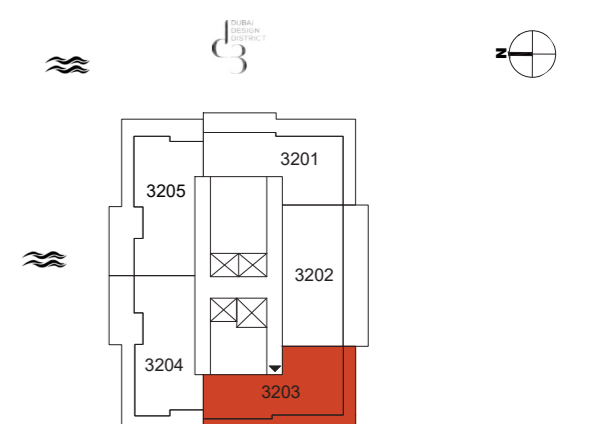

Level 32



Tower A



Upper Floor



Lower Floor

Unit No.	Unit Area		Balcony Area		Total Area	
	Sqm	Sqft	Sqm	Sqft	Sqm	Sqft
3202	234.44	2523.49	58.59	630.66	293.03	3154.15

TOWER A
Duplex - 3 Bedroom Type 07

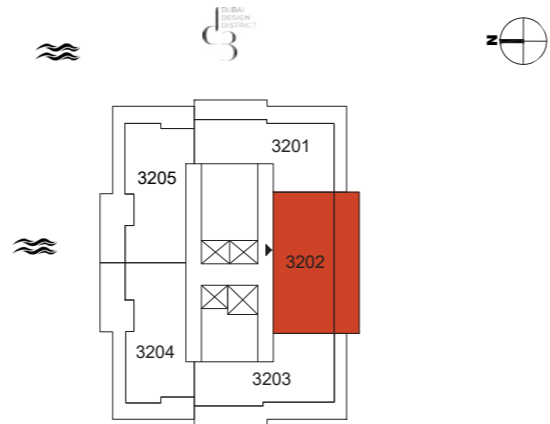

Level 32



Tower A

FLOOR PLANS
TOWER C

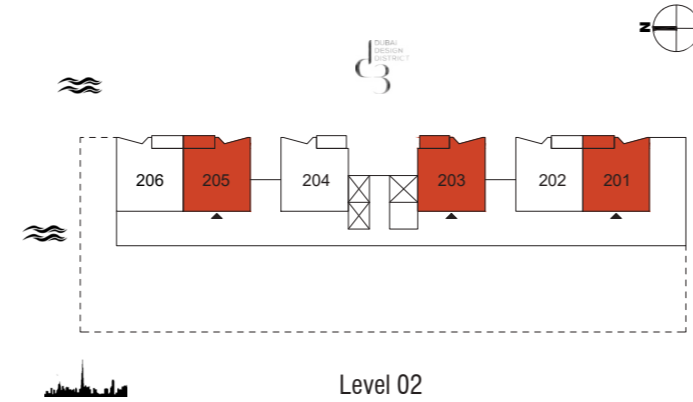

Unit No.	Unit Area		Balcony Area		Total Area	
	Sqm	Sqft	Sqm	Sqft	Sqm	Sqft
201	67.64	728.07	6.16	66.31	73.80	794.38
203	68.25	734.64	5.81	62.54	74.06	797.18
205	68.05	732.48	6.16	66.31	74.21	798.79

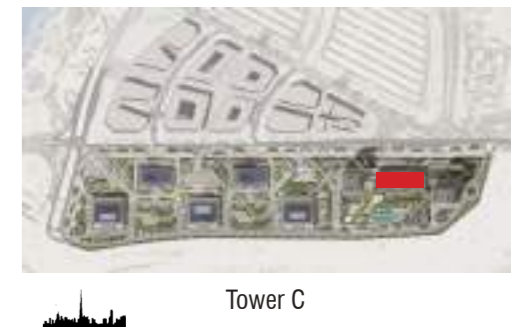
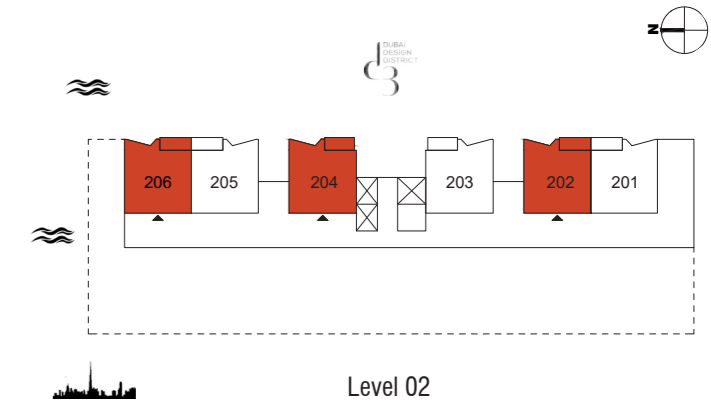

Unit No.	Unit Area		Balcony Area		Total Area	
	Sqm	Sqft	Sqm	Sqft	Sqm	Sqft
202	68.04	732.38	6.16	66.31	74.20	798.69
204	68.26	734.74	5.80	62.43	74.06	797.17
206	67.81	729.90	6.16	66.31	73.97	796.21

TOWER C
1 Bedroom Type 01



Unit No.	Unit Area		Balcony Area		Total Area	
	Sqm	Sqft	Sqm	Sqft	Sqm	Sqft
404 to 804	68.59	738.30	6.16	66.31	74.75	804.61
405 to 805	69.51	748.20	5.81	62.54	75.32	810.74
409 to 809	68.86	741.20	6.16	66.31	75.02	807.51

TOWER C
1 Bedroom Type 01 M

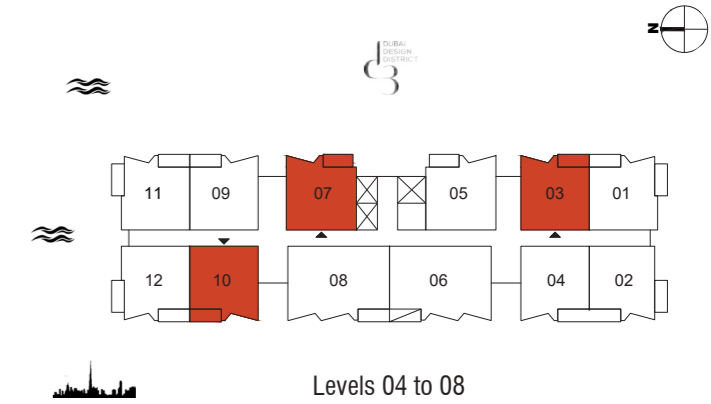

Unit No.	Unit Area		Balcony Area		Total Area	
	Sqm	Sqft	Sqm	Sqft	Sqm	Sqft
403 to 803	68.86	741.20	6.16	66.31	75.02	807.51
407 to 807	69.52	748.31	5.81	62.54	75.33	810.85
410 to 810	68.59	738.30	6.16	66.31	74.75	804.61

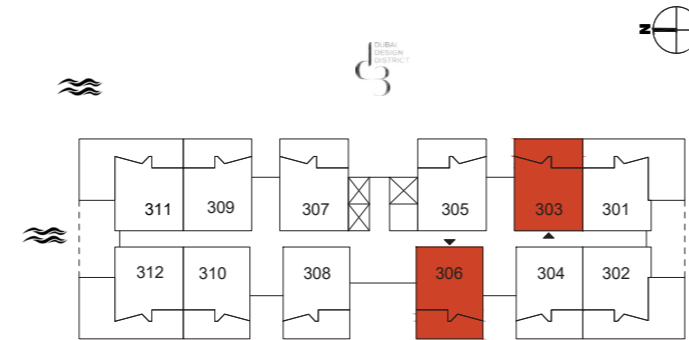

Level 03



Tower C

Unit No.	Unit Area		Balcony Area		Total Area	
	Sqm	Sqft	Sqm	Sqft	Sqm	Sqft
303	68.56	737.97	26.59	286.21	95.15	1024.18
306	67.72	728.93	26.86	289.12	94.58	1018.05

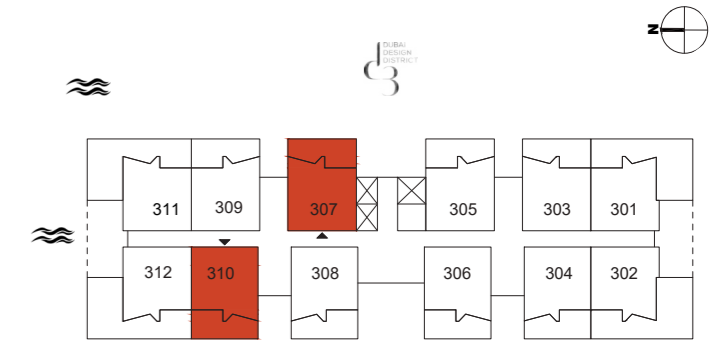

Level 03



Tower C

Unit No.	Unit Area		Balcony Area		Total Area	
	Sqm	Sqft	Sqm	Sqft	Sqm	Sqft
307	69.11	743.89	26.86	289.12	95.97	1033.01
310	67.72	728.93	26.59	286.21	94.31	1015.14

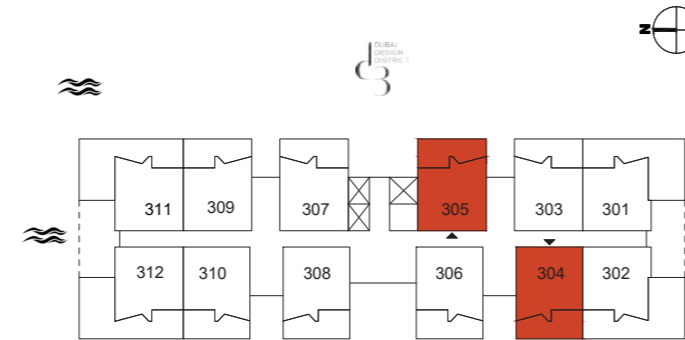

Level 03



Tower C

Unit No.	Unit Area		Balcony Area		Total Area	
	Sqm	Sqft	Sqm	Sqft	Sqm	Sqft
304	67.72	728.93	26.59	286.21	94.31	1015.14
305	68.77	740.23	26.86	289.12	95.63	1029.35

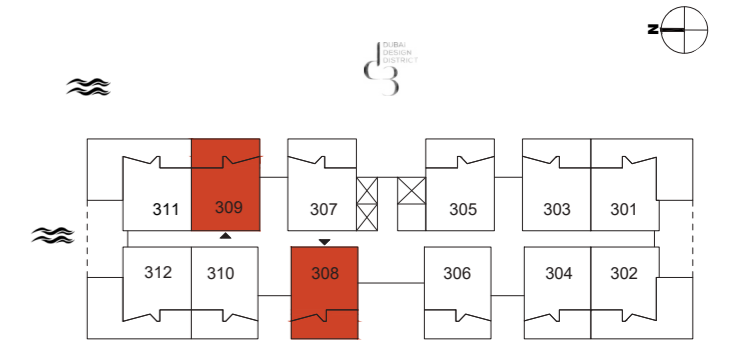

Level 03



Tower C

Unit No.	Unit Area		Balcony Area		Total Area	
	Sqm	Sqft	Sqm	Sqft	Sqm	Sqft
308	67.72	728.93	26.86	289.12	94.58	1018.05
309	68.57	738.08	26.59	286.21	95.16	1024.29

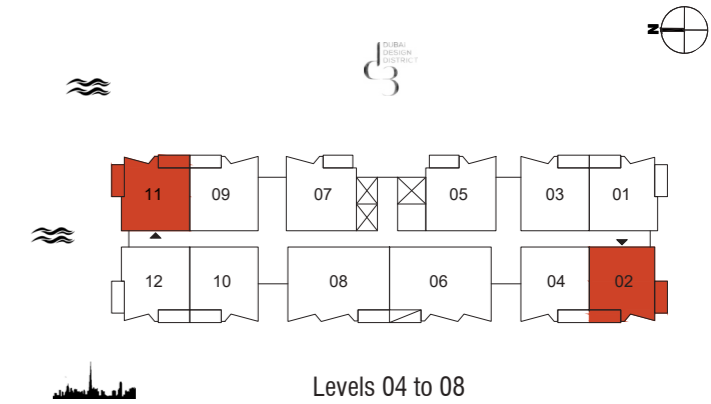
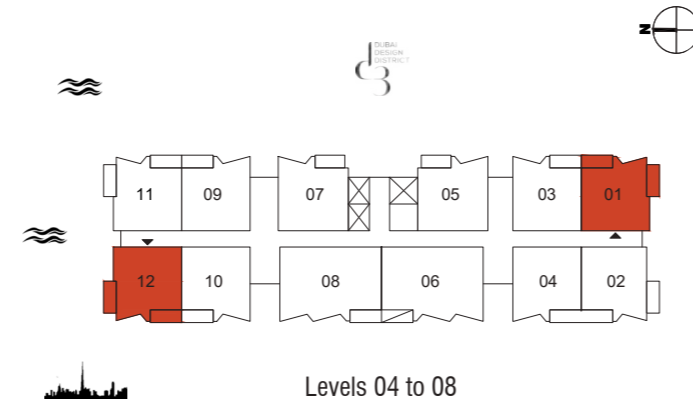

Unit No.	Unit Area		Balcony Area		Total Area	
	Sqm	Sqft	Sqm	Sqft	Sqm	Sqft
401 to 801	67.43	725.81	12.39	133.36	79.82	859.17
412 to 812						



Tower C

Unit No.	Unit Area		Balcony Area		Total Area	
	Sqm	Sqft	Sqm	Sqft	Sqm	Sqft
402 to 802	67.43	725.81	12.39	133.36	79.82	859.17
411 to 811						



Tower C

TOWER C
1 Bedroom Type 04 B

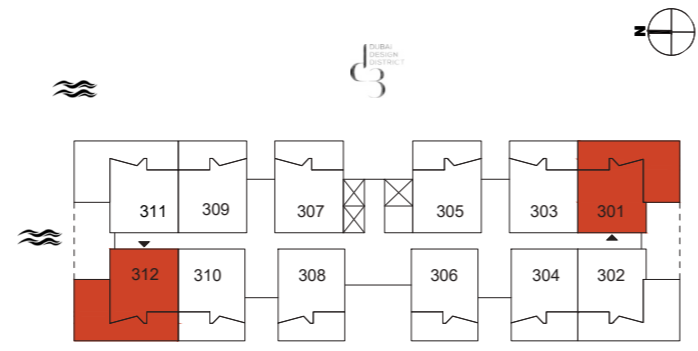

Level 03



Tower C

Unit No.	Unit Area		Balcony Area		Total Area	
	Sqm	Sqft	Sqm	Sqft	Sqm	Sqft
301	67.40	725.49	60.40	650.14	127.80	1375.63
312	67.40	725.49	60.39	650.03	127.79	1375.52

TOWER C
1 Bedroom Type 04 B M

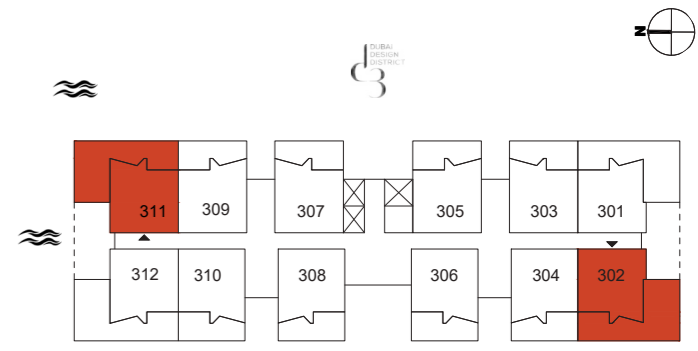

Level 03



Tower C

Unit No.	Unit Area		Balcony Area		Total Area	
	Sqm	Sqft	Sqm	Sqft	Sqm	Sqft
302	67.40	725.49	60.40	650.14	127.80	1375.63
311						

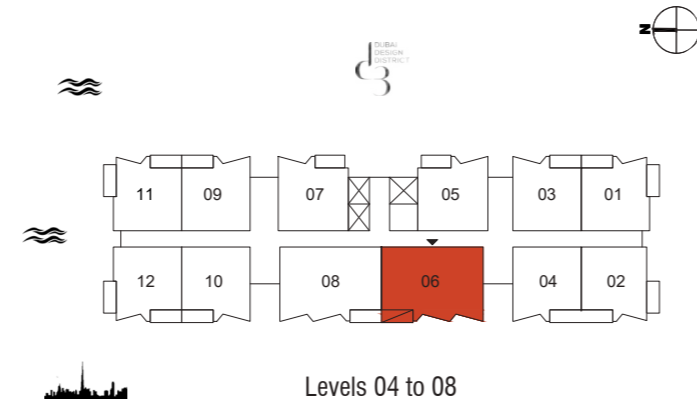

Tower C

Unit No.	Unit Area		Balcony Area		Total Area	
	Sqm	Sqft	Sqm	Sqft	Sqm	Sqft
406 to 806	104.72	1127.20	6.16	66.31	110.88	1193.51

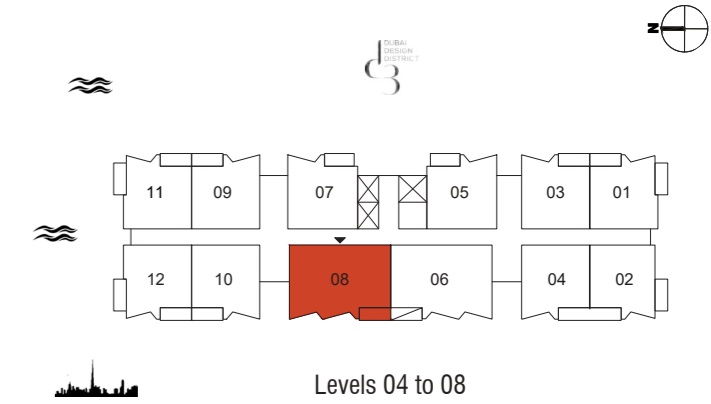

Tower C

Unit No.	Unit Area		Balcony Area		Total Area	
	Sqm	Sqft	Sqm	Sqft	Sqm	Sqft
408 to 808	104.72	1127.20	6.16	66.31	110.88	1193.51

TOWER C
2 Bedroom Type 04



Tower C

Lower Floor

Upper Floor

Unit No.	Unit Area		Balcony Area		Total Area	
	Sqm	Sqft	Sqm	Sqft	Sqm	Sqft
904	132.61	1427.40	100.41	1080.80	233.02	2508.20

TOWER C
2 Bedroom Type 04 M



Tower C

Lower Floor

Upper Floor

Unit No.	Unit Area		Balcony Area		Total Area	
	Sqm	Sqft	Sqm	Sqft	Sqm	Sqft
906	132.61	1427.40	100.54	1082.20	233.15	2509.60

TOWER C
3 Bedroom Type 04

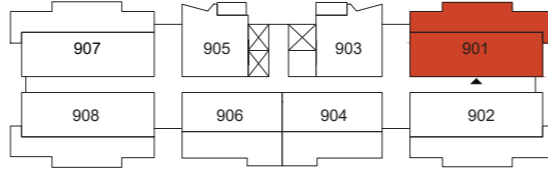

Level 09



Tower C

Lower Floor

Upper Floor

Unit No.	Unit Area		Balcony Area		Total Area	
	Sqm	Sqft	Sqm	Sqft	Sqm	Sqft
901	199.19	2144.06	74.94	806.65	274.13	2950.71

TOWER C
3 Bedroom Type 04

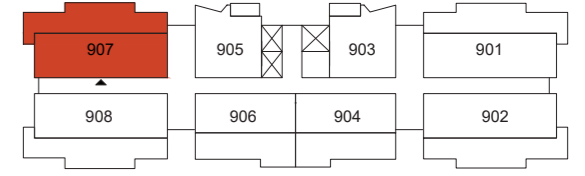

Level 09



Tower C

Lower Floor

Upper Floor

Unit No.	Unit Area		Balcony Area		Total Area	
	Sqm	Sqft	Sqm	Sqft	Sqm	Sqft
907	199.02	2142.23	75.40	811.60	274.42	2953.83

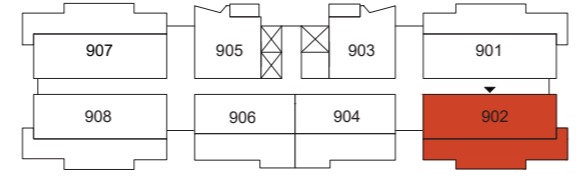

Level 09



Tower C

Lower Floor

Upper Floor

Unit No.	Unit Area		Balcony Area		Total Area	
	Sqm	Sqft	Sqm	Sqft	Sqm	Sqft
902	197.50	2125.87	74.01	796.64	271.51	2922.51

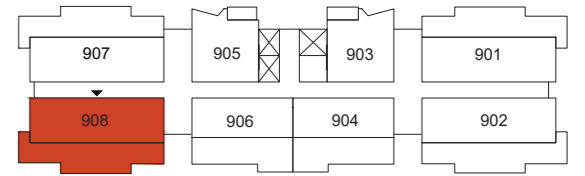

Level 09



Tower C

Lower Floor

Upper Floor

Unit No.	Unit Area		Balcony Area		Total Area	
	Sqm	Sqft	Sqm	Sqft	Sqm	Sqft
908	197.51	2125.98	73.99	796.42	271.50	2922.40





MERAAS

MERAAS.COM | 800 MERAAS